

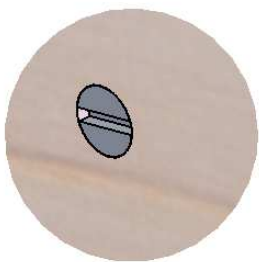





Wichtig!
Important!
Importante!



Schlitz-Position horizontal!
Position de la fente horizontale!
Posizione del taglio orizzontale!

- 1.  2 x Schrauben kurz
2 x Vis courtes
2 x Vite corte
- 2.  6 x Schrauben lang
6 x Vis longues
6 x Vite lunghe
- 3.  4 x Anti-Rutsch Puffer (für Sitz- und Fussteil)
4 x Tampon contre glissement (pour siège et repose-pied)
4 x Respingente contro scivolare (per sedile e poggiatesta)
- 4.  1 x Inbus - Schlüssel
1 x Clé six pans
1 x Brugola
- 5.  1 x Sicherheitsgurt
1 x Ceinture de sécurité
1 x Cintura di sicurezza

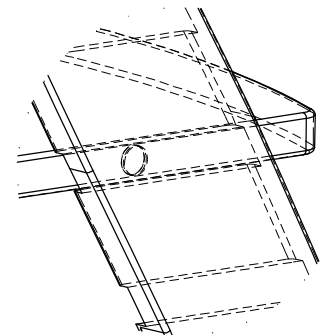

Richtige Position für Sitz- und Fussteil (Anti-Rutsch Puffer in die Bohrung kleben)
Position correcte pour la siège et le repose-pied (coller le tampon contre glissement dans le creux)
Posizione giusta per il sedile e poggiatesta (attachare il respingente contro scivolare nel avvallamento)

| | | | | | |
|---|---|--|-------------------------|--|--------|
|  Zwysigstrasse 28 CH-9000 St.Gallen Tel. 071 424 01 01 Fax 071 424 01 10 www.valida-sg.ch | Kinderstuhl Vivi erstellt: 27.06.2016/KOM revidiert: /KOM | | Art.Nr.: HO-vis-001-08 | | Pl.Nr. |
| | | | akt.Dat: 13.09.2017/KOM | | Mst |
| Dateiname: Montageanleitung Vivi20170710 | Kunde: - | | Auftr.Nr.: - | | |